

INSTALLATION & OWNER'S MANUAL

ALL IN ONE Type Air-source Heat Pump Water Heater

Thank you very much for purchasing our product,
Before using your unit, please read this manual carefully and keep it for future reference.



WARNING

This unit is required reliable earthing before usage, may otherwise result in death or injury.



If you can't make sure that your house power supply is earthed well, please don't install the unit.

The unit must be installed by a licensed tradesperson and in accordance with:

- Midea installation instructions.
- AS/NZS 3500.4-"National Plumbing and Drainage Code Hot Water Supply Systems-Acceptable Solutions".
- AS/NZS 3000-Wiring Rules.
- Local authority regulations.
- Building Codes of Australia
- Local Occupational Health and Safety (OH&S) Regulations.

NOTICE TO CUSTOMERS

This water heater must be installed by a licensed person as required by the Building Act. Only a licensed person will give you a compliance certificate, showing that the work complies with all the relevant standards and only a licensed person will have insurance protecting their workmanship for 6 years.

Please read and understand this booklet. If you have any questions, please contact our service representative on 1300 367 565.

HOT WATER CAN BE DANGEROUS

Warning – Hot water burns. As a safety precaution, young children should always be supervised around hot water fixtures.

Heat pump water heaters can store water at temperatures that can cause scalding. Water temperatures over 50°C can scald and care needs to be taken to ensure that injuries do not occur through incorrect use of your water heater.

As heat pump water heaters can generate water temperatures in excess of 60°C, regulations require that a tempering valve be fitted to the heater to prevent water temperatures going to the home exceeding a preset safe maximum. The tempering valve must be connected to the hot water outlet line from the water heater. The valve must be fitted by an authorized plumber at the time of installation or in retrofitting to existing systems.

Care should be taken to avoid coming into contact with any pipe work or fixtures associated with the water heater pipe lines. **Under NO circumstances should any 'home handy man' type modifications be attempted.**

- This appliance is not intended for use by persons (including children) with reduced physical sensory or mental capabilities, or lack of experience and knowledge, that prevents them from using the appliance safely without supervision or instruction. Children should be supervised by a responsible person for their safety to ensure that they do not play with the appliance.
- DANGER: Failure to operate the relief valve easing gear at least once every six months may result in the water heater exploding. Continuous leakage of water from the valve may indicate a problem with the water heater.
- **THE INSTALLATION MUST COMPLY WITH THE REQUIREMENTS OF AS/NZS 3500.4, AS/NZS 3000, and all local codes and regulatory authority requirements. In New Zealand, the installation must conform to the New Zealand Building Code G12.**

The power supply must be protected by an individual circuit breaker at the main electrical supply switchboard and rated to suit the booster size. The supply to the heat pump water heater can be operated directly from the switchboard or via a remotely mounted switch or time clock as requested by the customer. The heater must be provided with a suitable means for disconnecting the power supply.

PARTS NAMES

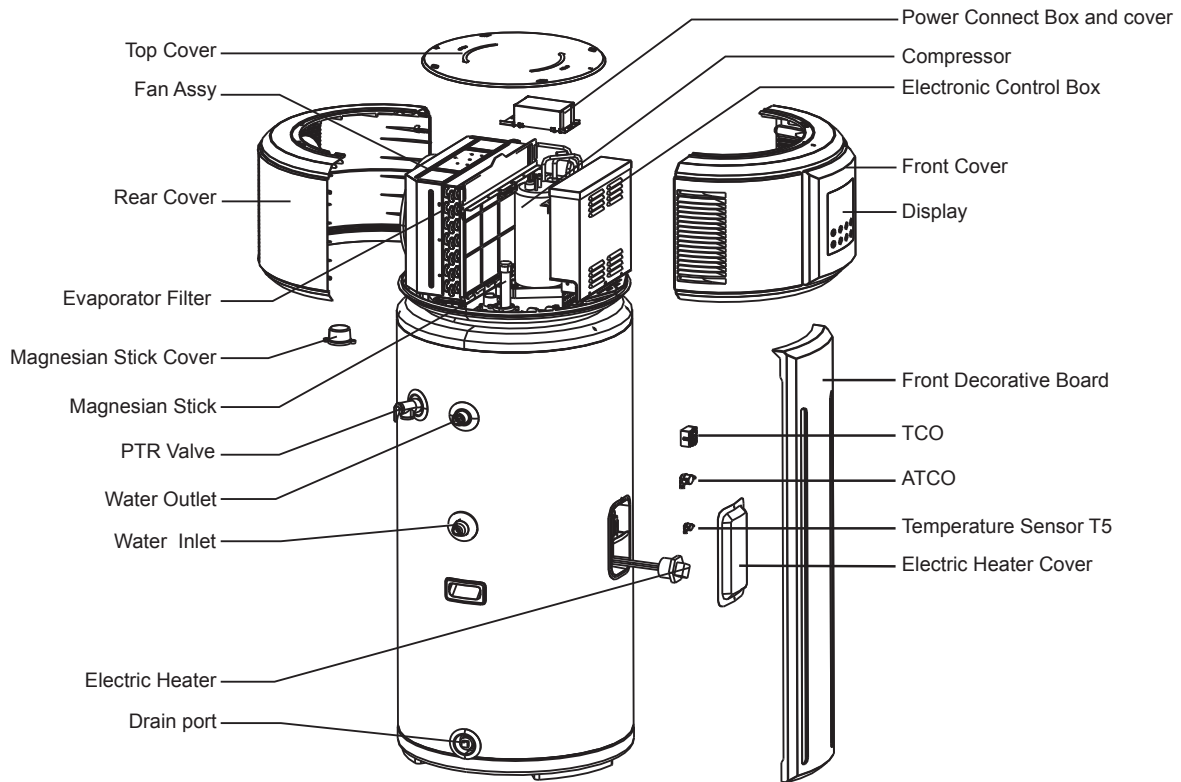

When ordering repair parts please always give the following information:

- 1) Model, serial and product number.
- 2) Part name on location.



NOTE

All the picture in this manual are for explanation purpose only. They may be slightly different from the heat pump water heater you purchased (depending on model). Please refer to the real product instead of the picture of this manual.

CONTENTS

PAGE

BASIC OPERATION PRINCIPLE..... 1
SAFETY INFORMATION..... 1
BEFORE INSTALLATION..... 2
INSTALLATION..... 4
TRIAL-RUNNING..... 6
OPERATION 9
TROUBLE SHOOTING.....12
MAINTENANCE.....14
SPECIFICATIONS.....15
MIDEA- HEAT PUMP MANUFACTURER'S WARRANTY..... 16

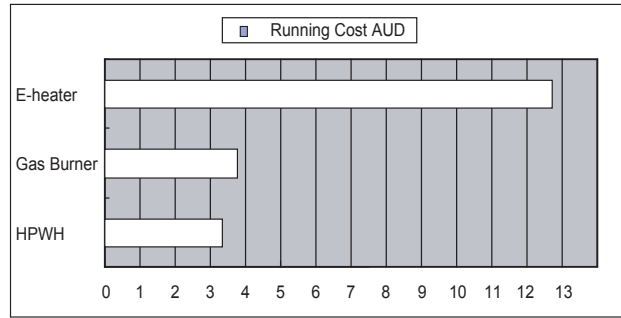

Fig. 1-1



NOTE

Above calculations are based on ideal conditions, the final amount will be different the actual running will vary with conditions, such as running period, ambient temperature, etc.

1. BASIC OPERATION PRINCIPLE

We know from experience, the natural flow of heat, moves from a higher to a lower temperature source, a heat pump can transfer heat from a lower temperature source to a higher temperature source with high efficiency.

The advantage of a heat pump water heater is that it can supply more heat energy, normally 3:1 times than input electricity power by extracting the heat from ambient atmosphere in a free-of charge way and transfer to Sanitary Hot Water. Compared to a traditional water heater, such as electric water heater or gas burner water heater, their efficiency is normally less than 1:1, which means you can dramatically cut off the bill of family daily SHW by the application of heat pump water heater, the following examples will show more details.

Power consumption comparison under the same condition to heat 1 ton of water from 15°C to 55°C.

$$Q=cM(T1-T2)=1(kCal/kg*°C)X1000(kg)X(55-15)(°C)=40000kCal=168MJ$$

$$=46.67kW*h$$

Table 1-1

	HPWH	Gas Burner	E-heater
Energy Resource	Air,Electricity	Gas	Electricity
Transfer Factor	860kCal/kW*h	8905kCal/m ³	860kCal/kW*h
Average Efficiency (W/W)	3.5	0.8	0.95
Energy Consumption	13.33kW*h	210MJ	49.13 kW*h
Unit Cost	0.25 AUD/kW*h	1.7C/MJ	0.25 AUD/kW*h
Running Cost AUD	3.33	3.57	12.28

2. SAFETY INFORMATION

Please read thoroughly all of the instructions before installing or operating the unit.

The following safety warnings are very important, always read and obey all safety symbols:



WARNING

- The unit must be earthed effectively.
- A RCD breaker must be installed adjacent to the power supply.
- Do not remove, cover or deface any permanent instructions, labels, or the data label from either the outside of the unit or inside of unit panels.
- Only qualified persons should perform the installation of this unit in accordance with local national regulations and this manual.

Improper installation may result in water leakage, electric shock or fire.
- Ask qualified person for relocating, repairing and maintaining the unit.

Improper installation may result in water leakage, electric shock or fire.
- Electric connection work should comply with the instructions of local power company, local electric utility and this manual.
- Never use an incorrectly fuse rated, otherwise the unit may break down and risk of electrical fire.
- Do not insert fingers, rods or other objects into the air inlet or outlet. The fan is rotating at high speed, and may cause injury.
- Never use a flammable spray such as hair spray, lacquer paint near the unit. It may cause a fire.
- This appliance is not intended for use by persons (including children) with reduced physical, sensory or mental capabilities, or lack of experience and knowledge, unless they have been given supervision or instruction concerning use of the appliance by a person responsible for their safety. Children should be supervised to ensure that they do not play with the appliance.

- If the supply cord is damaged, it must be replaced by the manufacturer or its service agent or a similarly qualified person.
- **DISPOSAL:** Do not dispose this product as unsorted municipal waste. Collection of such waste separately for special treatment is necessary. Do not dispose of electrical appliances as unsorted municipal waste, use separate collection facilities. Contact your local government for information regarding the collection systems available.
- If electrical appliances are disposed of in landfills or dumps, hazardous substances can leak into the groundwater and get into the food chain, damaging your health and well-being.



CAUTION

- The earthing pole of socket must be well grounded, make sure that power supply socket and plug are dry and connected tightly.
- Before cleaning, be sure to stop the operation and turn the breaker off or pull out the power plug. Otherwise, an electric shock and injury may be caused.

- Water temperature over 50°C can cause severe burns instantly or death from scalds. Children, disabled and elderly are at highest risk of being scalded. Feel water before bathing or showering. Water temperature limiting valves are required as per AS 3500.

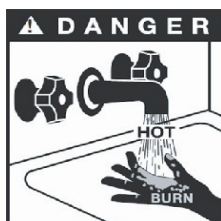

- Do not operate the unit with a wet hand. An electric shock may be caused.
- The installation height of power supply should be over 1.8m, if there is any water exposure, steps must be taken to separate the power supply from water.
- A one-way valve must be installed on the water inlet side, as well as an isolation valve.
- It is normal for some water to be released from the PTR valve during operation. But, if there is a large volume of water, call your service agent for instructions. After long term use, check the unit base and fittings. If damaged, the unit may sink, resulting in injury. Arrange the drain pipe to ensure smooth draining. Improper drainage work may cause wetting of the building, furniture etc. Do not touch the inner parts of the controller or remove the front panel. Some parts inside are dangerous to touch, and damage may be caused.
- Do not turn off the power supply.

System will stop or restart heating automatically. A continuous power supply for water heating is necessary, except service and maintenance.

Hydrogen gas is extremely flammable, and may build up if no water is drawn of for several weeks. To reduce the risk of injury under these conditions, it is recommended that the hot water tap is opened for several minutes at the kitchen sink before using any electrical appliance connected to the hot water system. When hydrogen is present, there will probably be an unusual sound such as air escaping through the pipe as the water begins to flow. There should be no smoking or open flame near the tap at the time it is open.

3. BEFORE INSTALLATION

3.1 Unpacking

3.1.1 Accessories

Table 3-1

Accessory Name	Qty.	Sharp	Purpose
Owner's & Installation Manual	1		Installation and use instruction This manual
Drain pipe for water condensation	1		Use for draining the condensate water (Has been connected to the lower condensate drain port)

3.1.2 How to transport

- 1) In order to avoid scratching or deforming the unit surface, apply guard boards to the contacting surfaces. No contact of fingers and other things with the vanes. Don't incline the unit more than 75° in moving, and keep it vertical when installing.

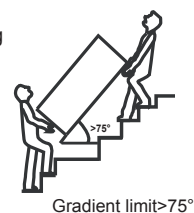

- 2) This unit is heavy, it needs to be carried by two or more persons, otherwise might cause injury and damage.

3.2 Location requirements

- 1) Enough space for installation and maintenance should be preserved.
- 2) The air inlet and outlet should be free from obstacles and strong wind.
- 3) The base surface should be flat, surface should be inclined no more than 2° and able to bear the weight of the unit and suitable for installing the unit without increasing noise or vibration.
- 4) The operating noise and air flow expelled should not affect neighbors.
- 5) No flammable gas nearby.
- 6) It should be convenient for piping and wiring.
- 7) If it is installed in indoor space, it might cause indoor temperature to decrease and noise, Please take preventive measures for this.
- 8) If the unit has to be installed on a metal part of building, make sure the electric insulation meets the relevant local electric standard.



CAUTION

- The ambient air temperature must also be considered when installing this unit, in heat pump mode the ambient air temperature must be above 5°C and below 43°C. If the ambient air temperature falls outside these upper and lower limits, the electrical elements will activate to meet the hot water demand and the heat pump will not operate.
- The unit should be located in an area not subject to freezing temperatures. A unit located in unconditioned spaces (i.e., garages, basements, etc.) may require the water piping, condensate piping, and drain piping to be insulated to shelter against freezing.



CAUTION

Installing the unit in any of the following places may lead to malfunction (If it is inevitable, consult the supplier prior to purchase).

- The site contains mineral oils such as lubricant of cutting machines.
- Seaside or where the air contains salt.
- Hot spring area where corrosive gases exist, e.g., sulfide gas.
- Factories where the power voltage fluctuates seriously.
- Inside a car or cabin.
- Places with direct sunlight and other heat supplies. If there's no way to avoid these, please install a cover.
- Places like kitchen where oil may permeate system.
- Place where strong electromagnetic fields exist.
- Place where flammable gases or materials exist.
- Place where acidic or alkaline gases exist.
- Other special environments.



WARNING

- The unit must be securely fixed, otherwise, noise and vibration may result.
- Make sure that there are no obstacle around the unit.
- In places where there are strong winds like seaside, fix the unit in a location protected from the wind.

3.3 Maintenance space requirements (unit: mm)

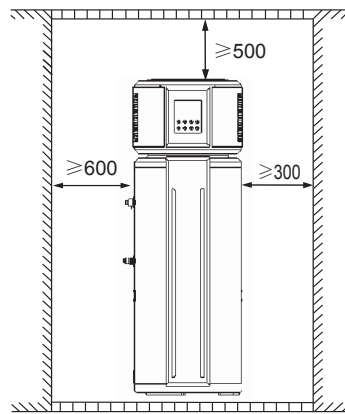
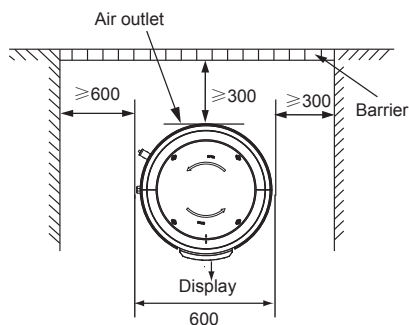

Fig.3-1

3.4 If installed in inclosed space

The water heater must be located in a space $>15\text{m}^3$, and must have unrestricted air flow. As an example, a room that has an 2.5 tall ceiling and is 3 meter long by 2 meter wide would contain 15m^3 .

3.5 Unit outline dimension (unit: mm)

Table 3-2

Model	RSJ-15/190RDN3-E
Dimension	
H	1580
ΦA	552
ΦB	568

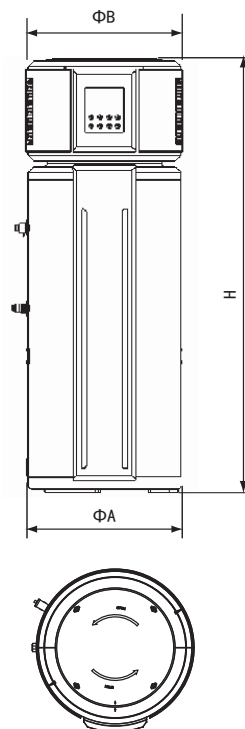

Fig.3-2

4. INSTALLATION

The circulating air for every unit should be more than 350m³/h. Make sure there is enough installation space. Refer outline dimensional drawing (see Fig.3-1, Fig.3-2)

4.1 Water System Piping

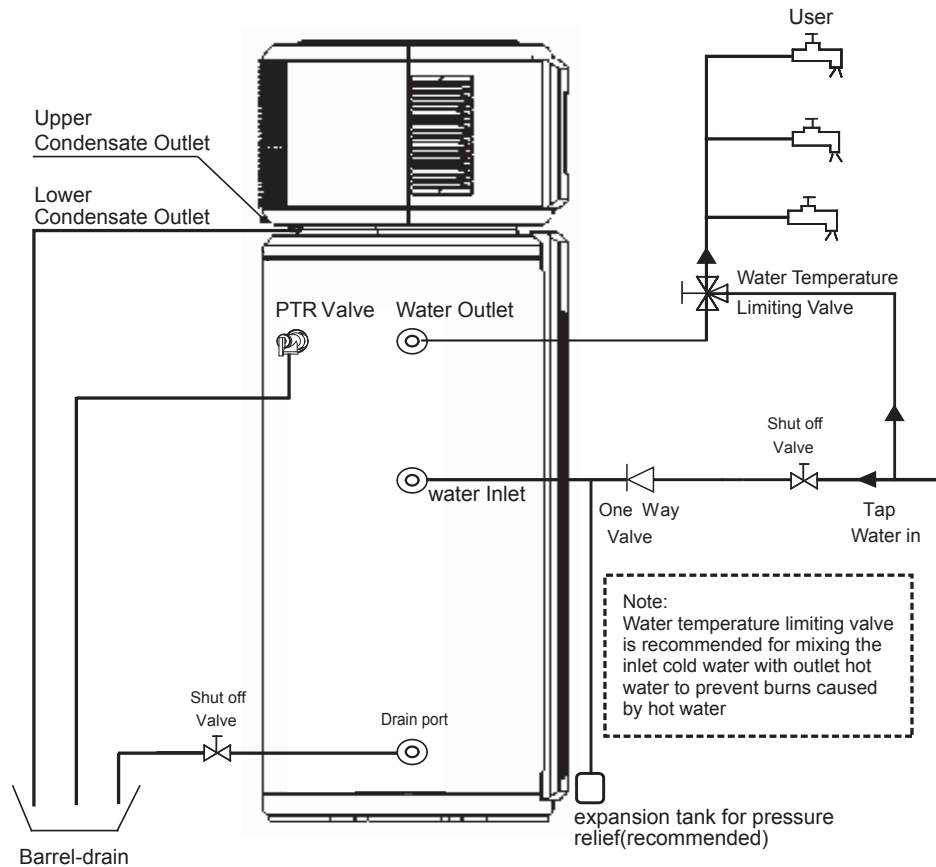

Fig. 4-1

- 1) Installation of the water inlet or outlet pipes: The water inlet & outlet thread is G3/4" (external thread). Pipes must be heat-resistant and durable.
- 2) Installation of the pipe for PTR valve: The valve connecting thread is RC3/4" (internal thread). After installation, it must be confirmed that the drainpipe outlet is exposed in the air. When drainpipe is joint to the pressure relief orifice of this valve, it must be confirmed that the flexible drainpipe is downwards vertically and exposed in the air.



CAUTION

- Piping water system as the above figure. In case of installing where outside temperatures fall below 5°C, insulation must be provided for all hydraulic components.
- The PTR Valve should be operated every 6 month to make sure that there is no restriction of the valve. Please beware of the hot water from the valve. The drainage pipe should be well insulated in order to prevent water inside pipe from freezing in cold weather.

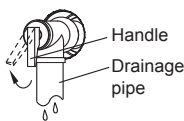

WARNING

- Do not dismantle the PTR Valve,
- Do not block off the Drainage pipe, it will cause explosion and injury.



- 3) Installation of the One Way Valve: The one way valve thread is RC3/4". It is used to prevent water from flowing backwards.
- 4) After connection of the water system piping work, turn on the cold water inlet valve and hot water outlet valve and bleed all air from the tank. When water flows smoothly out from water outlet pipe (tap water outlet), the tank is full, turn off all valves and check pipeline to make sure there is no any leakage.
- 5) If the inlet water pressure is less than 0.15MPa, a pump should be installed at the water inlet.

To guarantee the safe usage of tank, a reducing valve should be installed in the water inlet pipe if the water pressure exceeds 500kPa.

- 6) Condensate may leak from unit if drainage pipe is blocked, a drainage pan is recommended as shown as following figure:

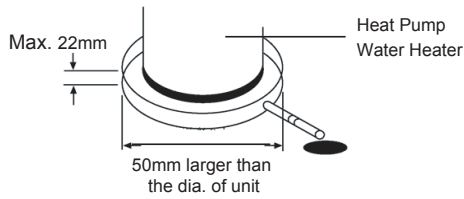

Fig. 4-2

4.2 Installation verticality requirement

To smoothly drain condensate from unit, please install the main unit is on a horizontal floor. Otherwise, please ensuring the drain vent is at the lowest place. Recommended inclination angle of unit to the ground should be no more than 2°.

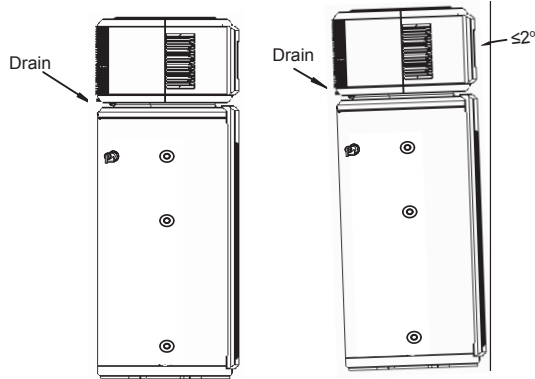

Fig. 4-3

4.3 Electric Connection

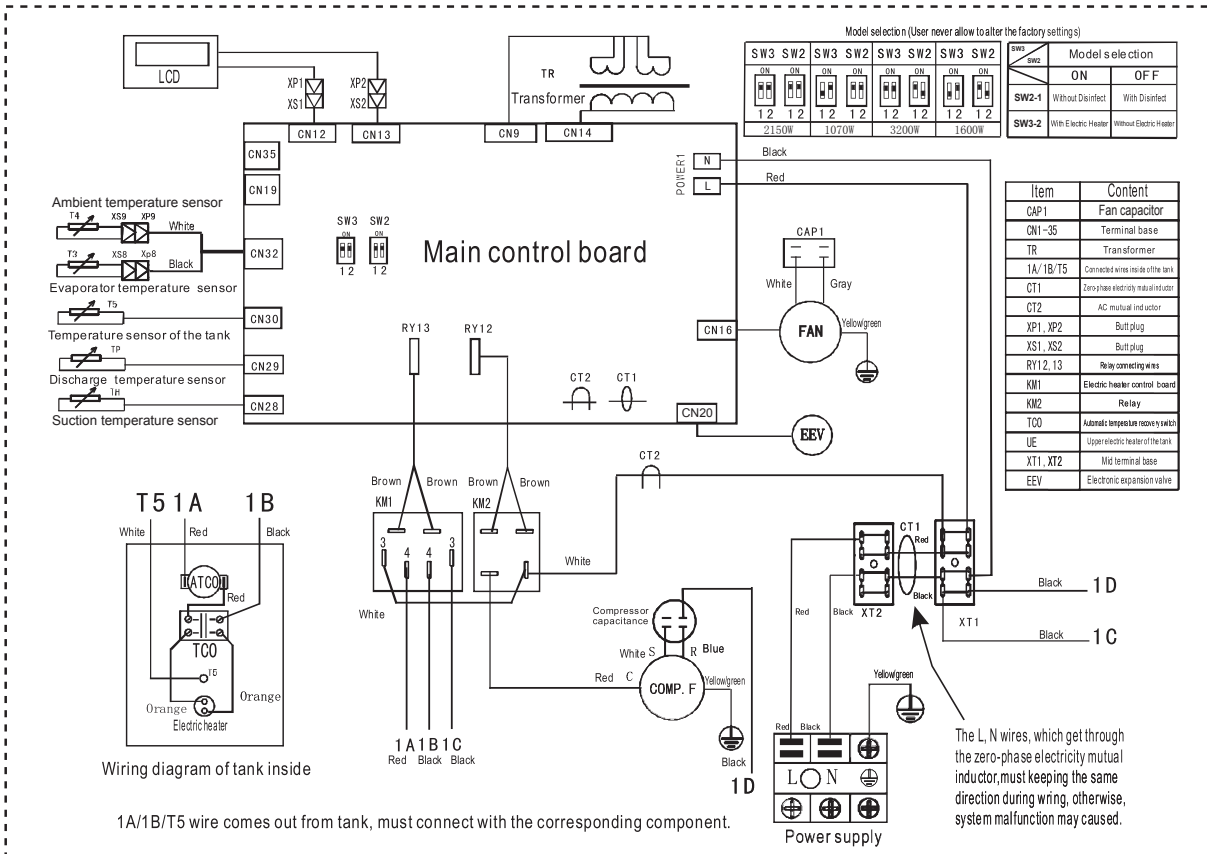

Fig. 4-4

- T3: Evaporator Temp. Sensor
- T4: Ambient Temp. Sensor
- T5L: Tank Temp. Sensor
- TP: Discharge Temp. Sensor
- TH: Suction Temp. Sensor
- Earthing

4.3.1 Electric Wiring Illustration



CAUTION

- Set the electric leakage protector according to the relevant electric technical standards of the State.
- The power cord and signal cord shall be laid out neatly and properly without mutual interference or contacting the connection pipe or valve.
- After wire connection, check it again and make sure of connection before power is turned on.



WARNING

The unit must be installed with an RCD near the power supply and must be effectively earthed.

4.4 Installation checklist

4.4.1 Location

- 1) The flooring beneath the water heater must be able to support the weight of the water heater when filled with water (286kg full).
- 2) Located indoors (such as a basement or garage) and in a vertical position. Sheltered from freezing temperatures.

- 3) Provisions made to shelter the area from water damage.
Metal drain pan installed and piped to an adequate drain.
- 4) Sufficient room to service the water heater.
- 5) Sufficient air for the heat pump to function, the water heater must be located in a space >15m², and must have unrestricted air flow.
- 6) The unit cannot be placed into any type of closet or small enclosure.
- 7) The site location must be free from any corrosive elements in the atmosphere such as sulfur, fluorine, and chlorine. These elements are found in aerosol sprays, detergents, bleaches, cleaning solvents, air fresheners, paint, and varnish removers, refrigerants, and many other commercial and household products. In addition excessive dust and lint may affect the operation of the unit and require more frequent cleaning.
- 8) The ambient air temperature must be above 5°C and below 43°C. If the ambient air temperature falls outside these upper and lower limits the electrical element will be activated to meet the hot water demand.

4.4.2 Water System Piping

- 1) PTR valve (Temperature and pressure relief valve) properly installed with a discharge pipe run to an adequate drain and sheltered from freezing.
- 2) All piping properly installed and free of leaks.
- 3) Unit completely filled with water.
- 4) Tempering valve installed per manufacturer's instructions.
Condensate Drain Line Installed.

Must be located with access to an adequate drain or condensate pump.

Condensate drain lines installed and piped to an adequate drain or condensate pump.

4.4.3 Electrical Connections

- 1) The water heater requires 220~240 VAC for proper operation.
- 2) Wiring size and connections comply with all local applicable codes and the requirements of this manual.
- 3) Water heater and electrical supply are properly grounded.
- 4) Correctly sized overload fuse or circuit breaker protection installed.

4.4.4 Post Installation Review

- 1) Understand how to use the User Interface Module to set the various modes and functions.
- 2) Understand the importance of routine inspection/maintenance of the condensate drain pan and lines. This is to help prevent any possible drain line blockage resulting in the condensate drain pan overflowing.
- 3) **IMPORTANT:** Water coming from the plastic shroud is an indicator that both condensation drain lines may be blocked. Immediate action is required.
- 4) To maintain optimal operation check, remove and clean the air filter.

5. TRIAL-RUNNING

5.1 Water affusion before operation

Before using this unit, please follow the steps below.

Water Affusion: If the unit is used for the first time or used again after emptying the tank, please make sure that the tank is full of water before turning on the power.

Method: see Fig. 5-1.

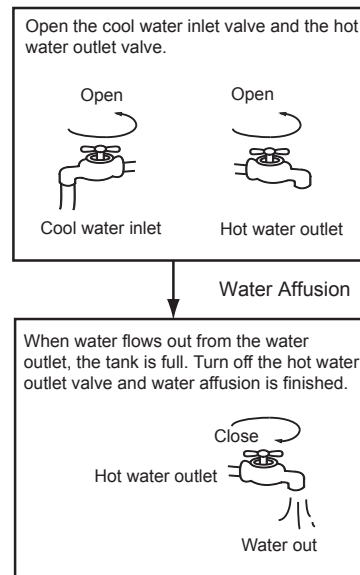
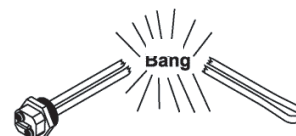

Fig.5-1



CAUTION

- Operation without water in water tank may result in the damage of auxiliary e-heater. In case of such damage, the manufacturer will not be liable for any damages caused by this issue.



- After powered on, the display lights up. Users can operate the unit through the buttons under the display.
- Emptying: If the unit needs cleaning, moving etc, the tank should be emptied.
Method: See Fig. 5-2:

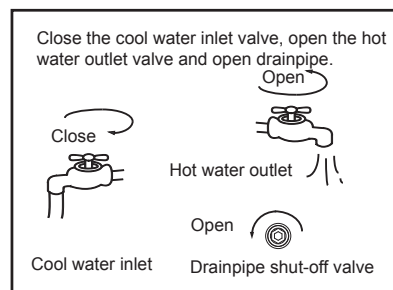

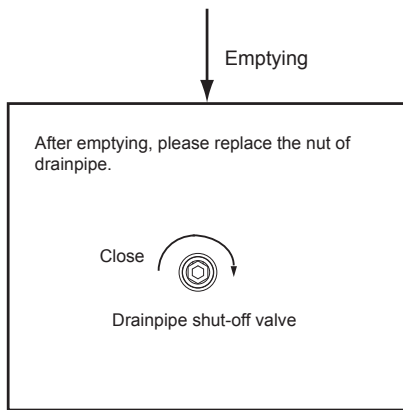

Fig.5-2

5.2 Trial- running

5.2.1 Check list before commissioning.

- 1) Check list before trial-running.
- 2) Correct installation of the system.
- 3) Correct connection of water/air piping and wiring.
- 4) Condensate draining smoothly well insulated for all hydraulic part.
- 5) Correct power supply.
- 6) No air in the water pipeline and all valves opened.
- 7) Effective RCD installed.
- 8) Sufficient inlet water pressure (between 0.15MPa and 0.65MPa) (150-650kPa).

5.2.2 About Running

- 1) System Structure Figure
This unit has two kinds of heat sources: Heat pump (compressor) and electric heater.
The unit will automatically select heat sources to heat water to the target temperature in different mode.

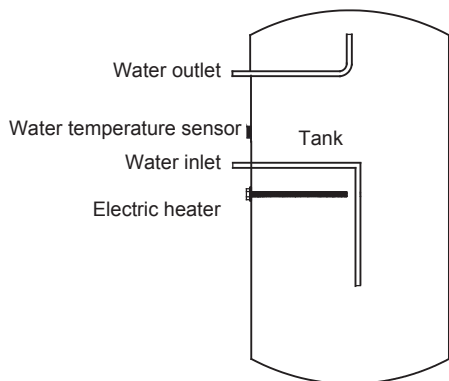

Fig.5-3

- 2) Water Temperature Display
The temperature shown on the display depends on the water temperature sensor. It is normal that sometimes the display temperature decreases while the unit is running, it is caused when the natural convection of the upper hot water mixes with by the bottom cold water which flows from inlet tap.

- 3) Operating mode should be selected manually. Refer to table 5-1.
Running Temperature Range
Water temperature limits:

Table 5-1

Operation mode	Ambient temp. range	Setting temp. range	Maximum temp. (Heat pump)
Economy mode	5~43	38~65	65
Hybrid mode	-20~43	38~70	65
E-heater mode	-20~43	38~70	--

- 4) Heat Source Shift

- ① The default heating source is heat pump.
If ambient temperature range is out of heat pump operating range, heat pump will stop running, the unit will shift automatically to activate E-heater and show the icon LA on the display, then if the ambient temperature goes into the running range of heat pump again, it will stop E-heater and shift automatically to heat pump again, and the icon LA will be extinguished.
- ② If the target water temperature is higher than maximum temperature (Heat pump), the unit will activate heat pump firstly to the maximum temperature, then stop heat pump, activate E-heater to continually heat water to the target temperature.



NOTE

If the system continuously reports heat pump protection, the latest error code and will be shown on the display, then heat pump will stop running, and the unit will shift automatically to E-heater mode as the backup mode, but the code and will be shown until power is reset.



NOTE

If only using E-heater mode, approx 60% of the tank water will be heated, so set a higher target water temperature if the ambient temperature is out of the heat pump running range.

- ③ Defrosting During Water-heating
In heat pump running period, if the evaporator becomes frosted in lower ambient temperature, the system will defrost automatically to keep effective performance (about 5~15min). At defrosting time, the compressor will stop, but fan motor will still run.
- ④ Heat-up Time
There are different heat-up times at different ambient temperatures. Normally lower ambient temperature result in longer heat-up times because of lower effective performance.

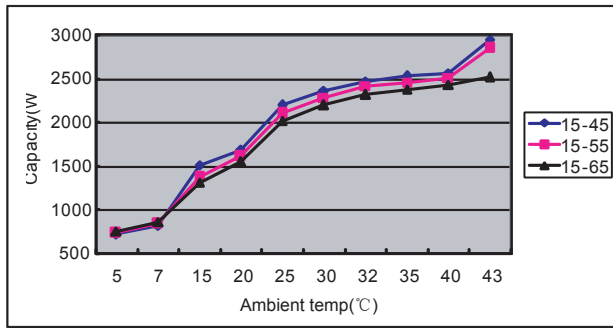

Fig. 5-4

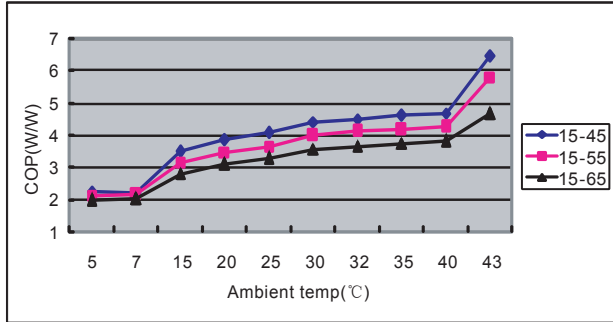

Fig. 5-5

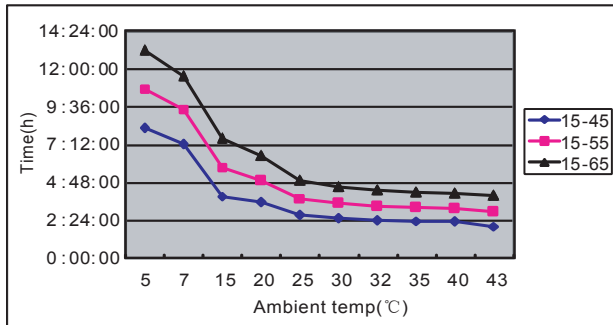

Fig. 5-6

⑤ About TCO and ATCO

The power of compressor and E-heater will be automatically shut-off or turn on by TCO and ATCO.

- If the water temperature is higher than 78°C, the ATCO will automatically shut off the power of compressor and E-heater, and turn it on if the temperature fall down below 68°C.
- If the water temperature is higher than 85°C, the TCO will automatically shut off the power of compressor and E-heater, it must be reset by an authorised service technician.

⑥ Restart After a Long Term Stop

When the unit is restarted after a long term stop (trail running included), it is normal that outlet water is unclear. Turn the tap on and the water will be flushed clean.



NOTE

While the ambient temperature is below 5°C, heat pump efficiency will decrease dramatically, the unit will automatically shift to E-heater mode.

5.2.3 Basic function

1) Weekly disinfect function

Under disinfection mode, unit immediately starts to heat water up to 65°C to kill any potential of legionella bacteria inside water of tank, ☼ icon will light on the display screen during disinfection; Unit will quit disinfection mode when water temperature is higher than 65°C and extinguish ☼ icon.

2) How to turn on the unit:

If unit is OFF->press ->button will be unlocked ->press

to select mode ->press to set target water temperature->press ->unit will automatically select mode and start to heat water to target temperature.

6. OPERATION

6.1 Control Panel Explanation

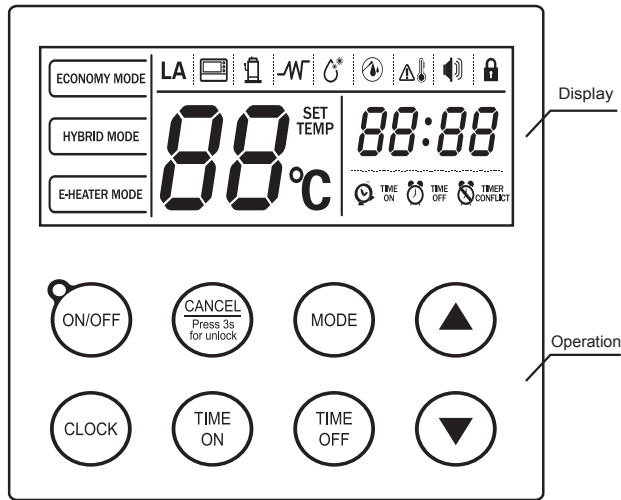

Fig. 6-1

6.2 Display Explanation

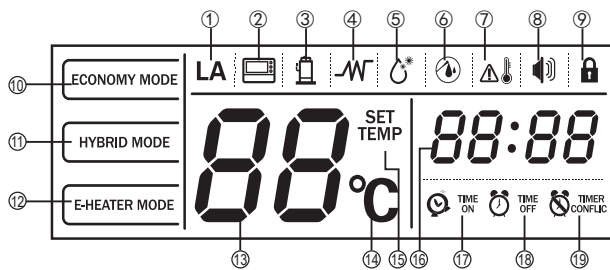

Fig. 6-2

Table 6-1

No	Icon	Description
①	LA	AMBIENT TEMP OUTSIDE THE OPERATIONAL RANGE OF HP: LA will be displayed if the ambient temp. is not in the operating range of the heat pump, otherwise LA will be extinguished.
②		WIRE CONTROLLER (Reserved function): will be displayed if connected to a wire controller, otherwise will be extinguished.
③		COMPRESSOR: will be displayed if compressor is activated, otherwise will be extinguished.
④		E-HEATER: will be displayed if e-heater is activated, otherwise will be extinguished.

No	Icon	Description
⑤		DISINFECTION: will be displayed when the unit is in disinfection mode, otherwise will be extinguished.
⑥		FILL WATER: will be displayed and flash with 1Hz frequency when the unit is re-powered on if the unit was off at last time of power on, then if press once, will be displayed without flashing, then press again, will be extinguished all the time. will not be displayed when the unit is re-powered on if the unit was on at last time of power on.
⑦		HIGH TEMP: If target water temp. is higher than 50°C, will be lightened, otherwise will be extinguished.
⑧		ALARM: When unit is displaying protection/error, will flash with 5Hz frequency as well as buzzer sounding 3 times every minute until protection/error eliminated or press for 1 second.
⑨		LOCK: will be displayed if buttons are locked, otherwise will be extinguished.
⑩		ECONOMY MODE: will be displayed if unit is operating in Economy Mode. When selecting mode, will flash with 1Hz frequency if Economy Mode is selected at the off time.
⑪		HYBRID MODE: will be displayed if unit is operating in Hybrid Mode. When selecting mode, will flash with 1Hz frequency if Hybrid Mode is selected at the off time.
⑫		E-HEATER MODE: will be displayed if unit is operating in E-heater Mode. When selecting mode, will flash with 1Hz frequency if E-heater Mode is selected at the off time.
⑬	88°C	WATER TEMP: 88 will be displayed all the time. 88 shows water temperature on normal time; 88 shows setting temperature when setting temperature; 88 shows unit setting/running parameters, error/protection code under query mode.
⑭	°C	TEMP-UNIT: °C will be displayed if 88 displays temperature, otherwise °C will be extinguished.

15	SET TEMP	SET-TEMP: SET TEMP will be displayed when setting water temp., otherwise SET TEMP will be extinguished.
16	88:88	CLOCK: 88:88 will be displayed all the time. 88:88 shows current clock on normal time; 88:88 shows setting clock when setting timer.
17	TIME ON	TIME ON: TIME ON will be displayed if the timer is set.
18	TIME OFF	TIME OFF: TIME OFF will be displayed if the timer is set.
19	TIMER CONFLIC	TIME CONFLICT (Reserved function): TIMER CONFLIC will be displayed if the timer which has been set on the control panel is not the same as that set on the ware controller.

6.2.1 Operation interface

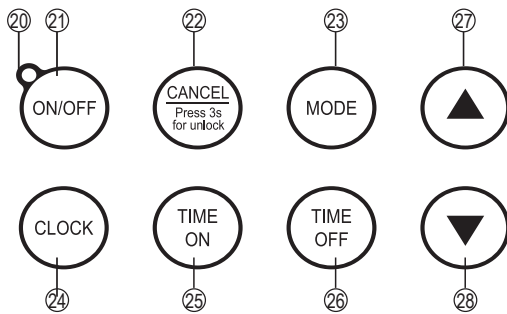

Fig. 6-3

Table 6-2

20		OPERATION INDICATOR: Water drop icon will be displayed if unit is ON, otherwise water drop icon will be extinguished.
21		<p>ON/OFF Press button ON/OFF can turn on or turn off the unit.</p> <p>Preparation before running the unit. When the unit is powered on for the first time, all the indicators on the display will be displayed for 3 seconds and the buzzer will “didi” ring twice at the same time, then, display the nominal page. After no operation for 1 minute, all indicators will be extinguished automatically except indicator (flash slowly) and water temperature. Buzzer will “di” ring when you press any button.</p> <p>CAUTION Confirm the tank is full of water or not when indicator is flashing.</p> <p>If tank is full of water, press the button ON/OFF, the indicator will stop flashing and you can continue to adjust other settings.</p> <p>When all settings finished, press the button ON/OFF again and the indicator will be extinguished. And then the unit will operate automatically.</p> <p>Auto-operation</p>

22		<p>Cancel Unlock Control Panel: In order to prevent wrong operation, a special lock function has been designed. If there is no operation for 1 minute, control panel will be locked automatically, and display the lock indicator . If the control panel is locked, no button can be operated. Press button for 3 seconds to unlock, then all buttons could be operated normally.</p>
23		<p>Mode Selection Press button to select operation mode. The unit can operate with three modes: Economy Mode, Hybrid Mode and E-heater Mode. Economy mode is the normal mode.</p> <p>ECONOMY MODE: The unit can heat water only by heat pump system in this mode. The suitable operation ambient temperature range is 5~43°C.</p> <p>HYBRID MODE: The unit can heat water by heat pump system, e-heater, or together in this mode. The suitable operation ambient temperature range is -20~43°C. In this mode, if ambient temperature is lower than 5°C, e-heater is the only heat source. If the ambient temperature is between 5°C and 10°C, e-heater and the heat pump will active together. If the ambient temperature is higher than 10°C, it will only activate the heat pump when water temperature is lower than 65°C and only active e-heater when water temperature is higher than 65°C.</p> <p>E-HEATER MODE: The unit can heat water only by e-heater in this mode. The suitable operation ambient temperature range is -20~43°C.</p>
24		<p>Set Clock The clock is for a 24-hour system and the initial time is 00:00. To make a better use of this unit, it is recommended to set the time for accurate local time. Every time powered off, the clock will be reset to the initial time 00:00.</p>

25

TIME ON

Set Timer-TIME ON ONLY

Time on only:

If the Timer is set to TIME ON, the unit will automatically operate once between the setting of the clock and the last 24 hours.

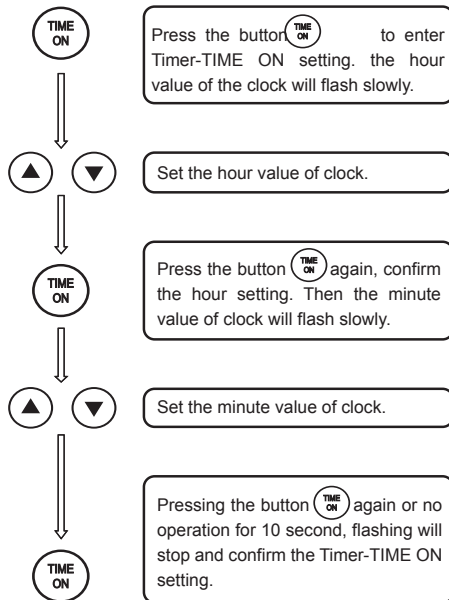

Cancel Timer-TIME ON ONLY

In the unlocked state, press the button  for 3 second and the Timer-TIME ON function will be canceled.

26

TIME OFF

Set Timer-TIME ON & TIME OFF

Time on & Time off:

If set the Timer-TIME ON & TIME OFF, the unit will automatically operate between the setting TIME ON clock and TIME OFF clock.

If the TIME OFF clock is the same as TIME ON clock, TIME OFF clock will be delayed 10 minutes automatically.

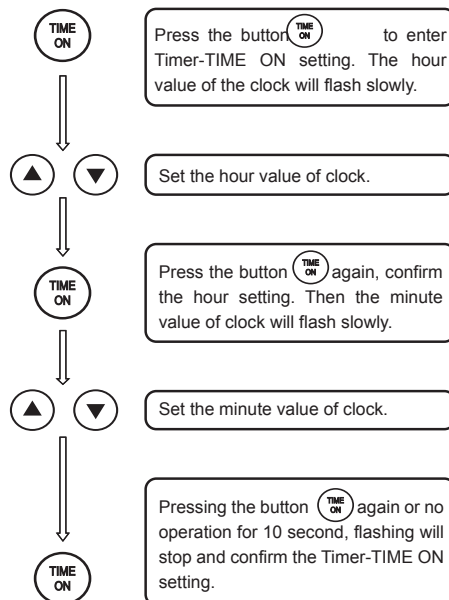

27

▲

INCREASE/UP

If button is unlocked, corresponding value will increase by pushing ▲.

- When setting temperature, press ▲ for more than 1s, temperature value will be increased continuously;
- When Setting clock/timer, press ▲ for more than 1s, Clock/timer value will be increased continuously.

28







▼

DECREASE/DOWN

If button is unlocked, corresponding value will decrease by pushing ▼.

- When setting temperature, press ▼ for more than 1s, temperature value will be decreased continuously;
- When Setting clock/timer, press ▼ for more than 1s, Clock/timer value will be decreased continuously.

6.3 Combination button

No.	Icon	Description
Clear error code	 + 	Press the two buttons at the same time to clear all stored error & protect codes, and the buzzer will buzz one time.
Query mode	 + 	Press the two buttons at the same time for 1sec to go into query mode. Under query mode user can check unit setting & running parameters by pressing   circularly. Press button  for 1s or no button operation for 30s, then quit query mode.

6.4 Auto-restart

If power is disconnected, the unit can remember some of the setting parameters (On or Off state, operating mode, setting water temperature); when it re-powers on, the unit will be operated as per the previous settings.

6.5 Button Auto Lock

When there is no operation of button for 1 minute, buttons will be locked except Unlock button . Press  for 3s, unlock buttons.

6.6 Screen Auto Lock

If there is no operation of button for 30s, screen back light will be extinguished. Press any button will lighten the screen back light.

7. TROUBLE SHOOTING

7.1 Non-error tips

Q: Why can't the compressor start immediately after setting?

A: Unit will wait for 3 min to balance the pressure of system before starting compressor again, it is a self protection logic for the unit.



Q: Why is the temperature shown on the display panel sometimes decrease while unit is running?

A: When the upper tank temperature is much higher than the bottom part, upper part hot water will be mixed with the bottom cold water which flows from inlet tap water, so that will decrease the average temperature.

7.2 Something about self-protection of unit



1) When the self-protection mode activates, the system will be stopped and start a self-check, and restart when the error is resolved.

2) When the self-protection mode activates, the buzzer will buzz every second minute, the  will flash and error code will be

shown at water temperature indicator. Press  button for 1sec to stop buzz, but the  and error code will not disappear until the error is resolved.

- 3) In the following circumstance, self-protection may happen:
 If air inlet or outlet is blocked;
 If the evaporator is covered with too much dust;
 Incorrect power supply (exceeding the range of 220-240V).

7.3 When Error happens

- 1) If some cases of error happen, the unit will automatically shift to E-heater for emergency SHW supply, please contact authorised technician to repair.
- 2) In case of serious errors, the unit will not start, please contact authorised technician to repair.
- 3) For some errors, the buzzer will buzz 3 times every other minute and the  will flash fast. Press  for 1 sec to stop the buzzer but the alarm icon will keep flashing.

7.4 Trouble shooting

Table. 7-1

Error phenomenon	Possible reason	solution
Cold water out and display screen extinguished	<ol style="list-style-type: none"> 1. Bad connection between power supply plug and socket; 2. Setting water temperature too low; 3. Temper sensor broken ; PCB of indicator broken; Compressor broken. 	<ol style="list-style-type: none"> 1. Plug in; 2. Setting water temp. higher; 3. Contact service center.
No hot water out	<ol style="list-style-type: none"> 1. Public water supply ceased; 2. Cold water inlet pressure too low (<0.15 Mpa); 3. Cold water inlet valve closed. 	<ol style="list-style-type: none"> 1. Waiting for public water supply recover; 2. Waiting for inlet water pressure increase; 3. Open water inlet valve.
Water leakage	Hydraulic pipeline joints are not sealed well.	Check and reseal all joints.

7.5 Error code shooting table

Table. 7-2

Display	Malfunction Description	Corrective action
E1	Error of sensor T5L(lower water temperature sensor)	Maybe the connection between sensor and PCB is broken or sensor has been broken. Contact a qualified person to service the unit.
E2	Tank and wired controller communication error	The connection between controller and PCB is broken or PCB has been broken.
E4	Evaporator temperature sensor T3 error	The connection between sensor and PCB is broken or sensor has been broken. Contact a qualified person to service the unit.
E5	Ambient temperature sensor T4 error	The connection between sensor and PCB is broken or sensor has been broken. Contact a qualified person to service the unit.
E6	Compressor discharge temperature sensor TP error	The connection between sensor and PCB is broken or sensor has been broken. Contact a qualified person to service the unit.
E8	Electric leakage error If PCB current_induction_circuit check the current difference between L,N >14mA, system consider it as "electric leakage error"	Some wires have been broken or bad wiring connection. Contact a qualified person to service the unit.
E9	Compressor suction temperature sensor TH error	The connection between sensor and PCB is broken or sensor has been broken. Contact a qualified person to service the unit.
P8	E-heater open-circuit protection (IEH(Current difference E-heater on & e-heater off)<1A)	Maybe the E-heater has been broken or bad wiring connection after repair.
P2	High discharge temperature protection Tp>115℃, Protection active Tp<90℃, Protection inactive	System blocked, air or water or low refrigerant(leakage) in system (after repair), water temperature sensor malfunction, etc. Contact a qualified person to service the unit.
P4	Compressor overloaded protection (10 secs after compressor start up), Current checking starts , 1)only compressor running, if it is >7A , the compressor will be stopped and protected. 2)Compressor+e-heater on, if it is >IEH+7,the compressor will be stopped and protected.	Compressor broken, system blocked, air or water or too much refrigerant in system (after repair), water temperature sensor malfunction, etc.
LA	When the ambient temp T4 is out of Heat Pump running range (5 ~43℃) Heat Pump will stop, unit will show LA on the position of clock on display until T4 back to (5 ~43℃).	It is normal, and not necessary to repair.



NOTE

The diagnostic codes listed above are the most common. If a diagnostic code not listed above is displayed, contact residential technical assistance referencing the number on the front of this manual.

8. MAINTENANCE

8.1 Maintenance

- 1) Check the connection between power supply plug and socket and ground wiring regularly;
- 2) In some cold areas (below 0°C), if the system will be stopped for a long time, all the water should be released in case of freezing of inner tank and damage of E-Heater.
- 3) It is recommended to clean the inner tank and E-Heater regularly to keep an efficient performance.
 - ① Cut off the power.
 - ② Close the cold water inlet valve, open the hot water tap.
 - ③ Use a flexible pipe to connect the drain port to a suitable sewage draining exit. (The min. heat resistance of the drain pipe is not less than 93°C, if the drain pipe can not meet the requirement, please open the cold water inlet valve, open the hot water tap, until there is no hot water flow out.)
 - ④ Open the drain port of the water heater; drain out all the water in the inner tank. If it is needed, use water to wash the inner tank several times to clear the deposits.
 - ⑤ Close the drain port, re-fill the inner tank with water, and re-power on.
- 4) Check the anode every half year and change if required. For more details, please contact the supplier or the service.



NOTE

How to Change the anode

- Turn off the power, and turn off the water inlet valve.
- Open hot water tap, and decrease the pressure of the inner container.
- Open the drain port, and release about 20L water.
- Unscrew anode according to instruction.
- Replace with a new one, and make sure effective sealed.
- Open cold water valve until hot water flows out, and turn off the hot water tap.
- Restart and can be used normally.

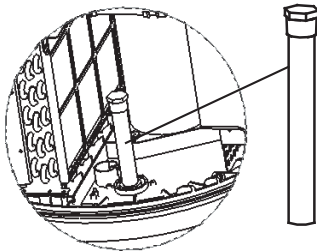

NOTE

How to Take Off The Air Filter, remove screw from top cover.

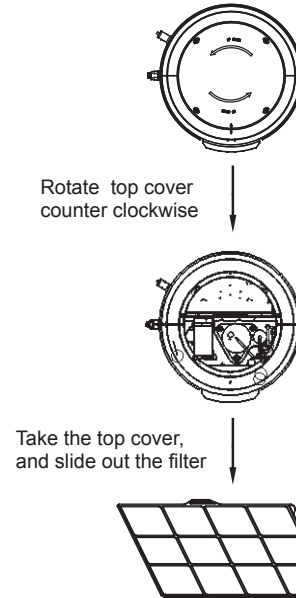

When installing the top cover please refer to the direction of arrow, after assembling it should be line up.

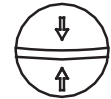

8.2 Recommended regular maintenance table

Table. 8-1

Checking Item	Checking content	Checking frequency	Action
1	air filter (inlet/outlet)	every month	Clean the filter
2	anode rod	every half year	Replace if required
3	inner tank	every half year	Clean the tank
4	e-heater	every half year	Clean e-heater
5	PTR valve	every year	Operate the handle of PTR valve to ensure that waterways are clear.
If water doesn't flow freely when operating the handle, replace PTR valve with a new one			

9. SPECIFICATIONS

Table 9-1

Model		RSJ-15/190RDN3-E				
Mode		Economy Mode	Hybrid Mode		E-Heater Mode	
Hot water heating cap.		1500W	Heat Pump	E-Heater	2150W	
			1500W	2150W		
Rated input power/current		780W/3.4A	2780W/12.1A		2150W/9.3A	
Power supply		220-240V~ 50Hz				
Protection		Over-load Protector, Temp Controller&Protector, Electric Leakage Protector, etc				
Compressor power		440W				
E-heater power		2150W				
Water pipeline system		Outlet water temp.		Default 63°C, (38°C-70°C adjustable)		
		Water side exchanger		Outer coil inner water tank		
		Inlet pipe Dia.		DN20		
		Outlet pipe Dia.		DN20		
		Drain water port Dia.		DN20		
		Safety valve Dia.		DN20		
		Maximum pressure		1.0MPa		
Exchanger air side		Material				Hydrophilic aluminum fin, inner groove copper tube
		Motor power		40W		
		Outlet air type		Air out from sideward		
Fusible link type		T20A 250VAC				
Refrigerant		R134a(800g)				
Dimension		Φ568×1580mm				
Water tank cap.		190L				
Net weight		90kg				
<p>The test conditions:</p> <p>1) Test temperature 15/12°C(DB/WB);</p> <p>2) Water temperature from 15°C up to 45°C.</p>						

10. MIDEA– HEAT PUMP MANUFACTURER’S WARRANTY

This warranty is provided by Midea. It applies to heat pumps installed in a single family dwelling only and is provided only to those acquiring the heat pump as consumers within the meaning of the Australian Consumer Law. The terms of the warranty are effective from the date the heat pump is installed. Midea may verify this date by requesting a copy of the compliance certificate that accompanied the installation. The compliance certificate is mandatory in all Australian states and territories.

10.1 Warranty period

Midea warrants that the following heat pump components will remain free of defects for the specified periods from the date of installation:

- Storage Tank - 5 years.
- Compressor- 3 years.
- All other components supplied by Midea, including valves, elements, thermostats and sacrificial anodes - 1 year.
- Midea gives no warranty in relation to components not supplied by Midea, for example tempering valves and cold water valve assemblies used by installers.

Subject to the conditions and exclusions specified in this warranty, Midea will at its own expense repair or replace any defective heat pump component covered by this warranty as soon as reasonably practicable after the consumer has reported the defect to Midea.

10.2 Consumers must register the warranty

To be eligible to make a claim under this warranty, consumers must complete all details in the Installation Report & Warranty Registration form provided with the heat pump within 6 weeks of installation and send it to the address shown on the form.

10.3 Procedure to make a claim under warranty

Upon discovering a suspected defect, consumers should immediately report the suspected defect:

- To the installer or supplier, if the suspected defect arises as a result of the installation of the heat pump or relates to any components not covered by this warranty.
- To Midea on the phone number below during the relevant warranty period, if the suspected defect relates to any components covered by this warranty.

10.4 Specific exclusions

To the extent permitted by law Midea does not accept liability under this warranty:

- 1) If any component of the heat pump has been installed, repaired, repositioned or modified by a person other than an appropriately qualified person approved by Midea in accordance with Midea’s installation and maintenance instructions and relevant local and statutory requirements;
- 2) For loss or damage caused by a fault or defect in the installation of the heat pump;
- 3) If corrosion has occurred because the anode has not been changed in accordance with the owner’s manual;
- 4) If a cold water expansion valve, check valve and strainer is not fitted in areas where mains pressure is likely to exceed 500 kPa;

- 5) For any damage arising as a result of an accident, act of God or other circumstances beyond Midea’s control;
- 6) If the inner cylinder has collapsed as a result of an incorrect filling and/or commissioning procedure;
- 7) For components not supplied by Midea that are used in the installation of Midea heat pump water heaters e.g. tempering valves, cold water valve assemblies, etc.
- 8) For extended or implied warranties not formally provided by Midea;
- 9) For external labour or equipment costs (e.g. cranes and lifting devices) required for repairs;
- 10) For costs incurred for rectifying faults (or perceived faults) not directly attributed to the Midea heat pump water heater;
- 11) For travel costs of service agents that exceed 30 kilometres;
- 12) For all consequential loss or damage arising from defects that can lawfully be excluded;
- 13) For any other issues not directly attributable to defects in components supplied by Midea including:
 - (a) Damage caused by incorrect commissioning;
 - (b) Leakage from valves not supplied by Midea;
 - (c) Leakage from the pressure temperature relief valve where the water pressure or temperature exceeds the limits specified in Midea’s installation and maintenance instructions;
 - (d) Water hammer;
 - (e) External rust on the storage tank;
 - (f) Insufficient hot water because:
 - (i) The consumer refuses to use the auxiliary booster;
 - (ii) Of an incorrectly set or faulty tempering or mixing valve;
 - (iii) Of faulty or incomplete installation;
 - (iv) The water heater is too small for its required purpose;
 - (v) Of insufficient water flow as a result of “water saving” tap-ware or appliances;
 - (vi) Of blown fuses, “tripped” electrical switches or inadequate household electrical wiring;
 - (vii) Insufficient water flow caused by debris accumulating in water strainer.

10.5 Important Note

The benefits conferred by this warranty are in addition to any other rights and remedies available to the consumer under a law in relation to the goods or services to which the warranty relates.

Midea’s goods come with guarantees that cannot be excluded under the Australian Consumer Law. Consumers are entitled to a replacement or refund for a major failure and for compensation for any other reasonably foreseeable loss or damage. Consumers are also entitled to have the goods repaired or replaced if the goods fail to be of acceptable quality and the failure does not amount to a major failure.

Contact Phone: 1300 367 565.

MDV11IU-055BW(DZ)

2020001A9998